

# Rollomatic $\varnothing 25$ mm // Shaft $\varnothing 20$ mm // RS $\varnothing 50$ mm

For Rollomatic tool grinding machines with ring set  $\varnothing 50$  mm

## GWA $\varnothing 25$ mm // $\varnothing 20$ mm // RS $\varnothing 50$ mm

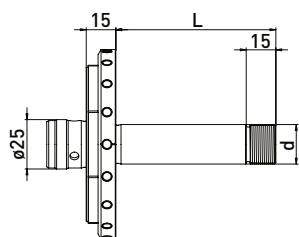
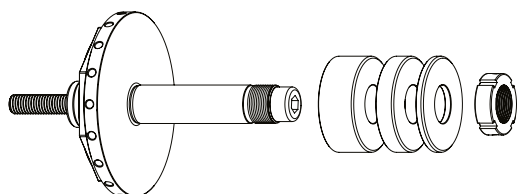

Delivered equipped:  
Ring set  $\varnothing 50$  mm, M10 clamping screw and clamping nut

### Ring set $\varnothing 50$ mm

Order No.	d	L	B 20	B 10	B 4
300150412	20	50	-	2	4
300150422	20	81	1	3	4

## Accessories Rollomatic grinding wheel adapter $\varnothing 25$ mm // Shaft $\varnothing 20$ mm // RS $\varnothing 50$ mm

Order No.	Name
350040051	Hook wrench 30 - 32 mm



Order No.	Name
350011520	Spacer ring Rollomatic $\varnothing 50$ x $\varnothing 20$ x 20
350011510	Spacer ring Rollomatic $\varnothing 50$ x $\varnothing 20$ x 10
350011504	Spacer ring Rollomatic $\varnothing 50$ x $\varnothing 20$ x 4
350020120	Clamping nut MRR20x1 M20 x 1 - $\varnothing 32$ x 10
350015003	Support washer $\varnothing 50$ x $\varnothing 75$ x $\varnothing 20$ x 6



# Rollomatic $\varnothing 25$ mm // Shaft $\varnothing 31,75$ mm ( $1\frac{1}{4}$ )

For Rollomatic tool grinding machines

GWA  $\varnothing 25$  mm //  $\varnothing 31,75$  mm ( $1\frac{1}{4}$ )

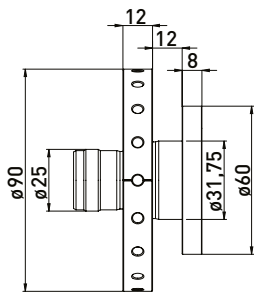
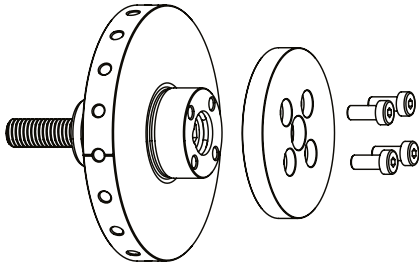

Delivered equipped:  
Clamping flange, 4pc. M5x12 cylinder screws and  
M10 clamping screw

Order No.	Name
300150510	Grinding wheel adapter Rollomatic $\varnothing 31,75$ x 11

# Rollomatic $\varnothing 25$ mm // Shaft $\varnothing 31,75$ mm ( $1\frac{1}{4}$ ) // RS $\varnothing 60$ mm

For Rollomatic tool grinding machines with ring set  $\varnothing 60$  mm

## GWA $\varnothing 25$ mm // $\varnothing 31,75$ mm ( $1\frac{1}{4}$ ) // RS $\varnothing 60$ mm

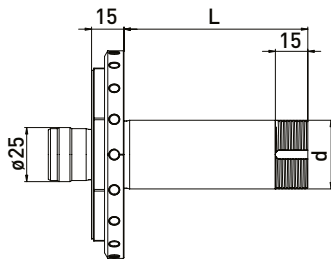
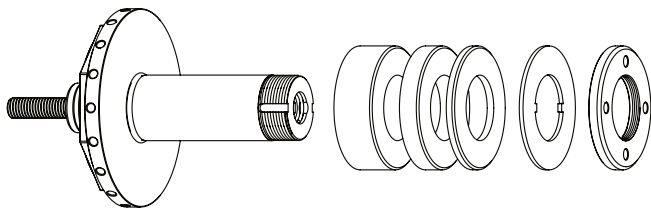





Delivered equipped:  
Ring set  $\varnothing 60$  mm, M10 clamping screw, lock washer and clamping nut

Order No.	d	L	Ring set $\varnothing 60$ mm		
			B 20	B 10	B 4
300150212	31,75	50	-	2	4
300150222	31,75	85	2	2	3
300150232	31,75	115	3	3	3

## Accessories Rollomatic grinding wheel adapter $\varnothing 25$ mm // $\varnothing 31,75$ mm ( $1\frac{1}{4}$ ) // RS $\varnothing 60$ mm

Order No.	Name
350040020	Clamping nut wrench PC45 for $\varnothing 32$ 

Order No.	Name
350011620	Spacer ring Rollomatic $\varnothing 60 \times \varnothing 31,75 \times 20$ 
350011610	Spacer ring Rollomatic $\varnothing 60 \times \varnothing 31,75 \times 10$ 
350011604	Spacer ring Rollomatic $\varnothing 60 \times \varnothing 31,75 \times 4$ 
350030060	Lock washer $\varnothing 60 \times \varnothing 32 \times 1,8$ 
350020066	Clamping nut $\varnothing 60 \times 6 \times M32 \times 1,5$ PC45 

# Rollomatic $\varnothing 25$ mm // Shaft $\varnothing 32$ // RS $\varnothing 60$ mm

For Rollomatic tool grinding machines with ring set  $\varnothing 60$  mm

## GWA $\varnothing 25$ mm // $\varnothing 32$ mm // RS $\varnothing 60$ mm

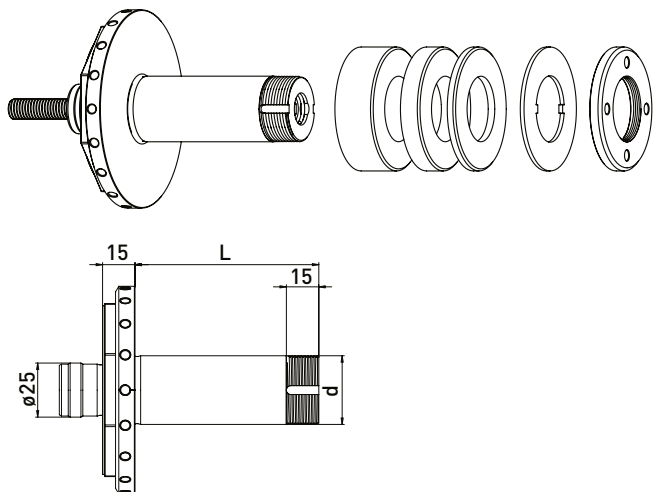







Delivered equipped:

Ring set  $\varnothing 60$  mm, M10 clamping screw lock washer and clamping nut

Order No.	d	L	Ring set $\varnothing 60$ mm		
			B 20	B 10	B 4
300150312	32	50	-	2	4
300150322	32	85	2	2	3
300150332	32	115	3	3	3

## Accessories Rollomatic grinding wheel adapter $\varnothing 25$ mm // Shaft $\varnothing 32$ mm // RS $\varnothing 50$ mm

Order No.	Name
350040020	Clamping nut wrench PC45 for $\varnothing 32$ 

Order No.	Name
350011620	Spacer ring Rollomatic $\varnothing 60 \times \varnothing 31,75 \times 20$ 
350011610	Spacer ring Rollomatic $\varnothing 60 \times \varnothing 31,75 \times 10$ 
350011604	Spacer ring Rollomatic $\varnothing 60 \times \varnothing 31,75 \times 4$ 
350030060	Lock washer $\varnothing 60 \times \varnothing 32 \times 1,8$ 
350020066	Clamping nut $\varnothing 60 \times 6 \times M32 \times 1,5$ PC45 

# Rollomatic $\varnothing 25$ mm // stepped Shaft $\varnothing 25$ , $\varnothing 35$ , $\varnothing 50$ mm

For Rollomatic tool grinding machines

## GWA $\varnothing 25$ mm // stepped Shaft

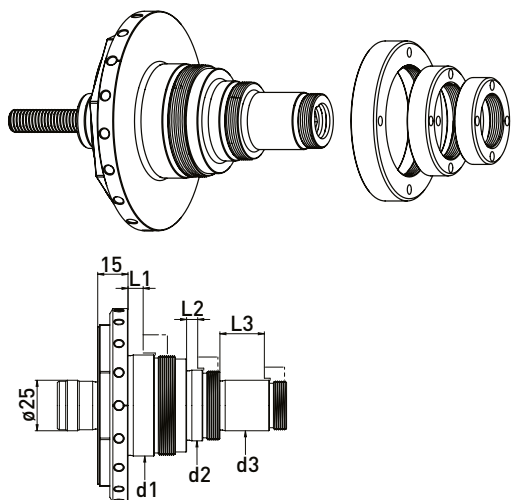

Delivered equipped:

per 1 piece clamping nut  $\varnothing 38$  (350020110),  $\varnothing 48$  (350020111),  $\varnothing 70$  (350020113) and M10 clamping screw

Order No.	L1	L2	L3	d1	d2	d3
300150111	11,5	5,5	5,5	50	35	25
300150121	7,5	5,5	22	50	35	25

Delivered equipped:

per 1 piece clamping nut  $\varnothing 38$  (350020110),  $\varnothing 58$  (350020112) and M10 clamping screw

Order No.	L1	L2	L3	d1	d2	d3
300150131	11,5	5,5		40	25	

Delivered equipped:

per 1 piece clamping nut  $\varnothing 38$  (350020110),  $\varnothing 70$  (350020113) and M10 clamping screw

Order No.	L1	L2	L3	d1	d2	d3
300150141	11,5	5,5		50	25	

## Accessories Rollomatic grinding wheel adapter $\varnothing 25$ mm // stepped Shaft $\varnothing 25$ , $\varnothing 35$ , $\varnothing 50$ mm

Order No.	Name	for d
350020110	Clamping nut Rollomatic $\varnothing 38$ x 10 M24 x 1	25
350020111	Clamping nut Rollomatic $\varnothing 48$ x 10 M34 x 1	35
350020112	Clamping nut Rollomatic $\varnothing 58$ x 11 M39 x 1	40
350020113	Clamping nut Rollomatic $\varnothing 70$ x 12 M49 x 1	50

Order No.	Name
350016001	Spacer ring $\varnothing 38$ x $\varnothing 25$ x 5
350016002	Spacer ring $\varnothing 58$ x $\varnothing 40$ x 5
350016003	Spacer ring $\varnothing 70$ x $\varnothing 50$ x 5
350016005	Spacer ring $\varnothing 48$ x $\varnothing 35$ x 5

# Rollomatic HSK50 // stepped Shaft $\varnothing 25$ , $\varnothing 35$ , $\varnothing 50$ mm

For Rollomatic tool grinding machines

## GWA HSK50 // stepped Shaft

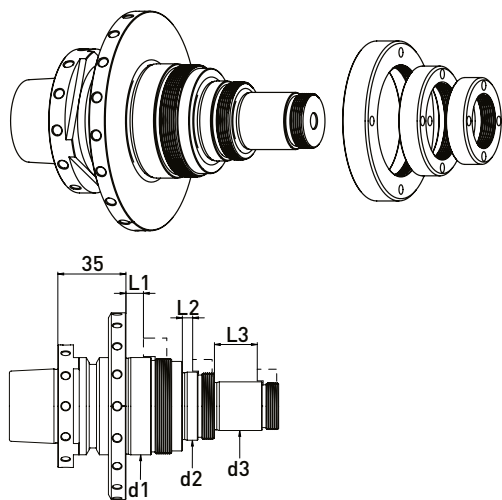

Delivered equipped:

per 1 piece clamping nut  $\varnothing 38$  (350020110),  $\varnothing 48$  (350020111),  $\varnothing 70$  (350020113) and M10 clamping screw

Order No.	L1	L2	L3	d1	d2	d3
300150921	7,5	5,5	22	50	35	25

## Accessories Rollomatic grinding wheel adapter $\varnothing 25$ mm // stepped Shaft $\varnothing 25$ , $\varnothing 35$ , $\varnothing 50$ mm

Order No.	Name	for d
350020110	Clamping nut Rollomatic $\varnothing 38$ x 10 M24 x 1	25
350020111	Clamping nut Rollomatic $\varnothing 48$ x 10 M34 x 1	35
350020112	Clamping nut Rollomatic $\varnothing 58$ x 11 M39 x 1	40
350020113	Clamping nut Rollomatic $\varnothing 70$ x 12 M49 x 1	50

Order No.	Name
350016001	Spacer ring $\varnothing 38$ x $\varnothing 25$ x 5
350016002	Spacer ring $\varnothing 58$ x $\varnothing 40$ x 5
350016003	Spacer ring $\varnothing 70$ x $\varnothing 50$ x 5
350016005	Spacer ring $\varnothing 48$ x $\varnothing 35$ x 5

# Rollomatic HSK-E50 // Shaft $\varnothing 20$ mm // RS $\varnothing 50$ mm

For Rollomatic tool grinding machines with ring set  $\varnothing 50$  mm

## GWA HSK-E50 // $\varnothing 20$ mm // RS $\varnothing 50$ mm

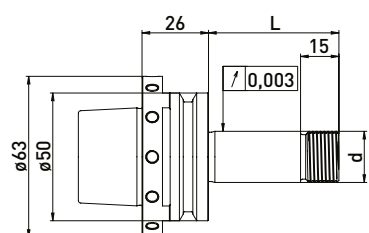
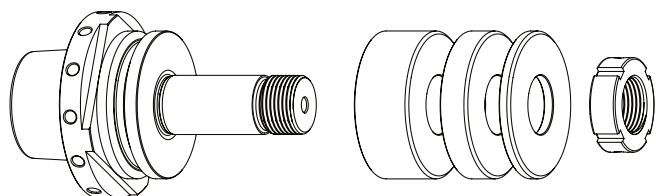

Delivered equipped:  
Ring set  $\varnothing 50$  mm and clamping nut

## GWA HSK-E50 // $\varnothing 20$ mm // without RS

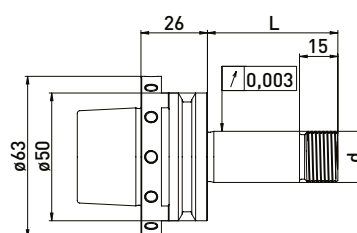
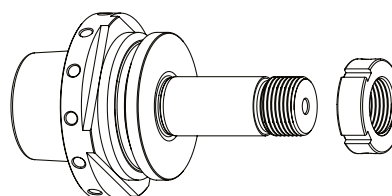

Delivered equipped:  
Clamping nut

### Ring set $\varnothing 50$ mm

Order No.	HSK	d	L	Ring set $\varnothing 50$ mm		
				B 20	B 10	B 4
300150612	HSK-E50	20	51	1	1	2
300150632	HSK-E50	20	81	2	2	2

Order No.	HSK	d	L
300150611	HSK-E50	20	51
300150631	HSK-E50	20	81

## Accessories Rollomatic grinding wheel adapter GWA HSK-E50 // Shaft $\varnothing 20$ mm // RS $\varnothing 50$ mm

Order No.	Name
350040051	Hook wrench 30 - 32 mm



Order No.	Name
350011520	Spacer ring Rollomatic $\varnothing 50 \times \varnothing 20 \times 20$
350011510	Spacer ring Rollomatic $\varnothing 50 \times \varnothing 20 \times 10$
350011504	Spacer ring Rollomatic $\varnothing 50 \times \varnothing 20 \times 4$
350020121	Clamping nut MRR20 x 1,5 M20 x 1,5 $\varnothing 32 \times 10$
350015003	Support washer $\varnothing 50 \times \varnothing 75 \times \varnothing 20 \times 6$



# Rollomatic HSK-E50 // Shaft $\varnothing 31,75$ mm (1¼) // RS $\varnothing 60$ mm

For Rollomatic tool grinding machines with ring set  $\varnothing 60$  mm

## GWA HSK-E50 // $\varnothing 31,75$ mm (1¼) // RS $\varnothing 60$ mm

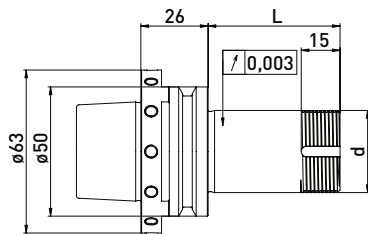
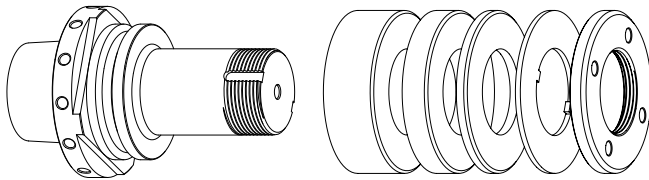

Delivered equipped:  
Ring set  $\varnothing 60$  mm and clamping nut

### Ring set $\varnothing 60$ mm

Order No.	HSK	d	L	B 20	B 10	B 4
300150712	HSK-50E	31,75	51	-	1	3
300150732	HSK-50E	31,75	81	1	1	3

## GWA HSK-E50 // $\varnothing 31,75$ mm (1¼) // without RS

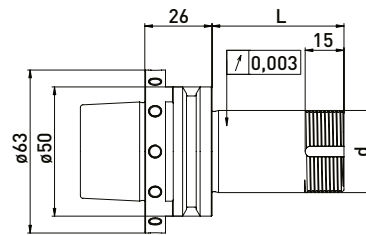
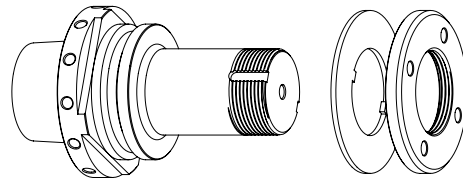

Delivered equipped:  
Clamping nut

Order No.	HSK	d	L
300150711	HSK-50E	31,75	51
300150731	HSK-50E	31,75	81

## Accessories Rollomatic grinding wheel adapter HSK-E50 // Shaft $\varnothing 31,75$ mm (1¼) // Ring set $\varnothing 60$ mm

Order No.	Name	
350040030	*Clamping nut wrench PC39 for clamping nut with blancing option	
350040020	Clamping nut wrench PC45 for $\varnothing 32$	
350020023	*Balancing weight pair for clamping nut $\varnothing 60$ // 200gmm	

Order No.	Name	
350011420	Spacer ring $\varnothing 60$ x $\varnothing 31,75$ x 20	
350011410	Spacer ring $\varnothing 60$ x $\varnothing 31,75$ x 10	
350011404	Spacer ring $\varnothing 60$ x $\varnothing 31,75$ x 4	
350030060	Lock washer $\varnothing 60$ x $\varnothing 32$ x 1,8	
350020066	Clamping nut $\varnothing 60$ x 6 x M32 x 1,5 PC45	
350020022	*Clamping nut with blancing option $\varnothing 60$ x 9 M32 x 1,5 PC39	

\*related items